

ENWORK

SKYLINE FREESTANDING TOPPER SCREENS INSTALLATION GUIDE

SCREENS



WARNING:

Acrylic screens scratch and scuff easily. After removing protective film, immediately and carefully install the screen.

DO NOT remove protective film from acrylic screens, then stack them in a pile or against each other. Experience shows this will cause marring and scratching.

ENWORK

INSTALLATION GUIDE

1) PARTS AND FASTENERS INCLUDED

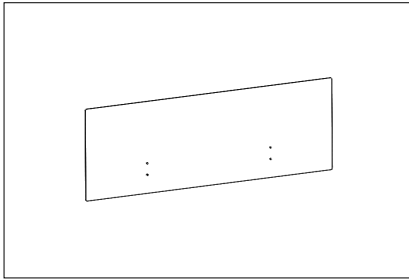

Screen Panel

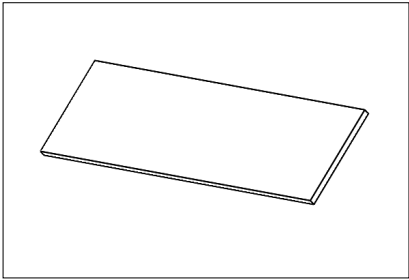

Tape

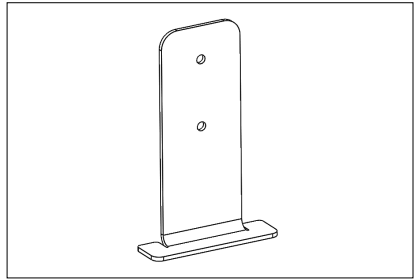

PNM-1947 BRACKET

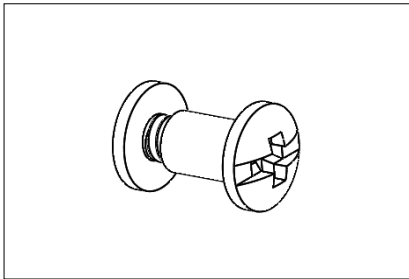

Binding Bolt Pair

2) TOOLS AND SUPPLIES REQUIRED

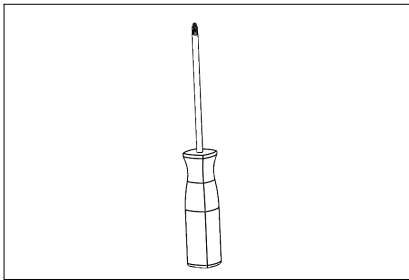

2x Phillips Screwdrivers

ENWORK

INSTALLATION GUIDE

3) ASSEMBLY :

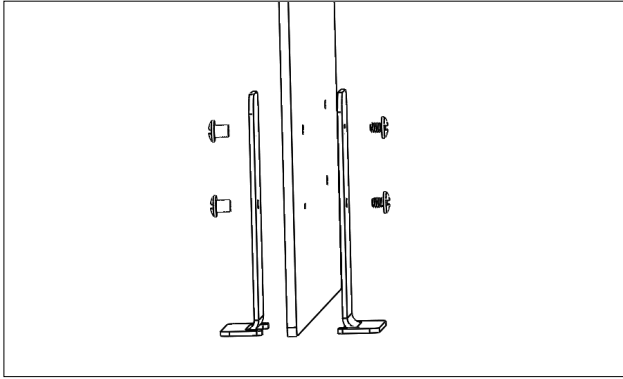

FIGURE 1

Sandwich the Acrylic or Acoustic Panel Screen between the Brackets, aligning the holes in the screen and the bracket. Attach them all together with the Binding Bolt pair.

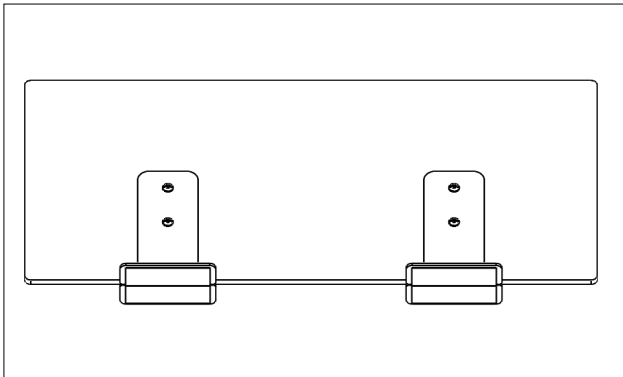

FIGURE 2

Peel one side of the tape off and stick it down centered onto each Bracket base.

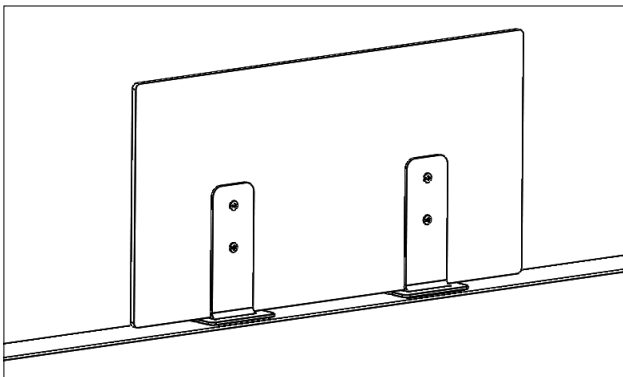

FIGURE 3

Peel the second backer off the tape and place the assembly in its desired location. Hold the assembly down firmly for 30 seconds to activate the tape.

**** NOTE: The tape cure time is 24 hours.
Please allow tape to cure before using screen.****

ENWORK

1.800.815.7251

www.enwork.com

12900 Christopher Dr. Lowell, MI 49331

Specifications subject to change without notice.

Rev 06.2020