

NOTES:

- DRAWING IS A VISUAL REPRESENTATION ILLUSTRATING DESIGN INTENT. DETAILS MAY VARY INCLUDING LOCATION OF POWER/DATA UNITS AND BASES.
- NO MORE THAN 4 STATIONS PER CIRCUIT

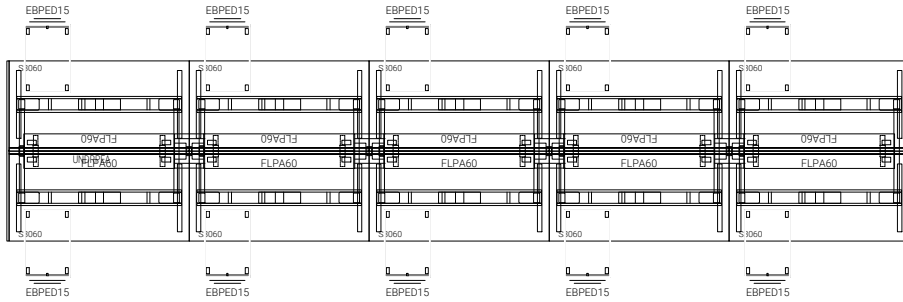

**PLAN VIEW**  
Scale: 3/8" = 1'-0"

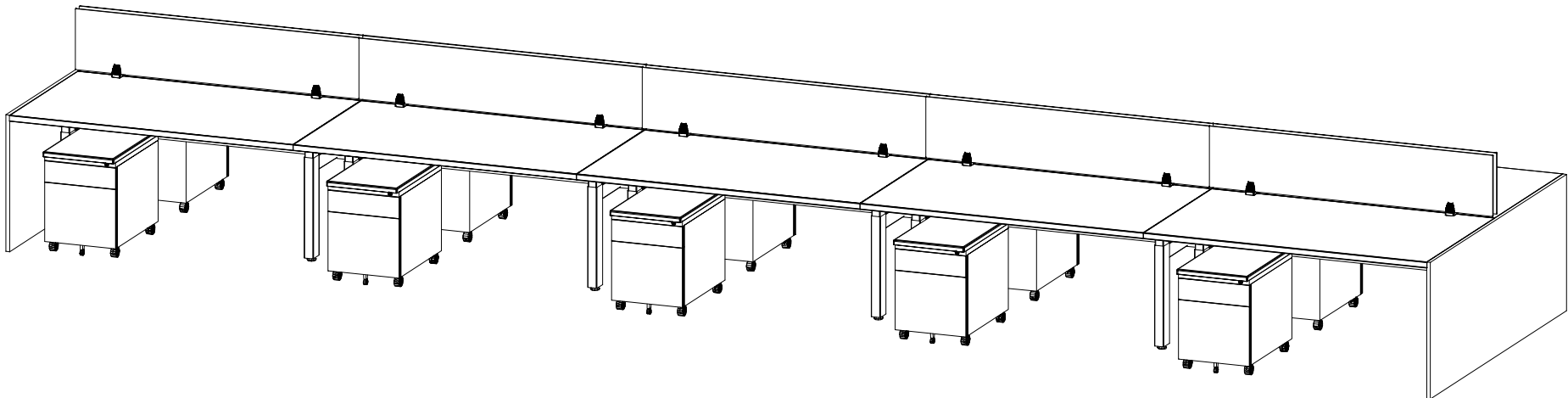

**ISOMETRIC VIEW**  
Scale: Not to Scale