

NOTES:

- DRAWING IS A VISUAL REPRESENTATION ILLUSTRATING DESIGN INTENT. DETAILS MAY VARY INCLUDING LOCATION OF POWER/DATA UNITS AND BASES.
- NO MORE THAN 4 STATIONS PER CIRCUIT

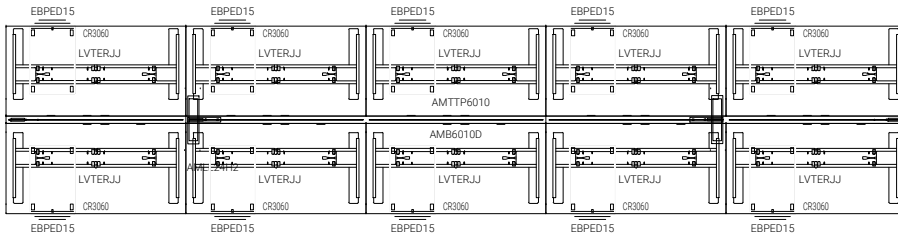

PLAN VIEW
Scale: 3/16" = 1'-0"

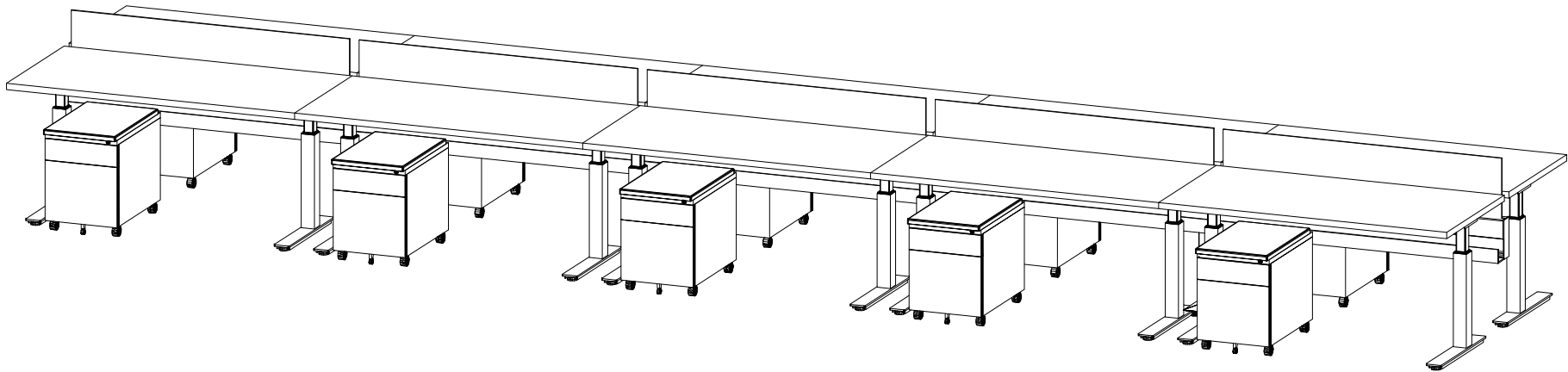

ISOMETRIC VIEW
Scale: Not to Scale